

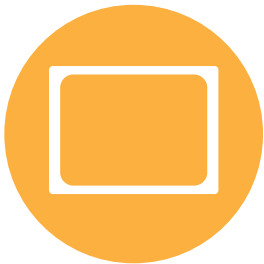

**My Book™**

*AV™*

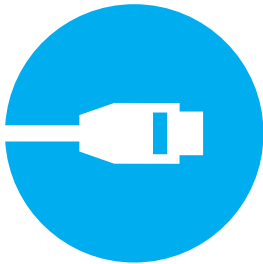



OR

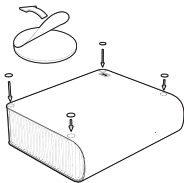

5°C - 40°C  
41°F - 104°F

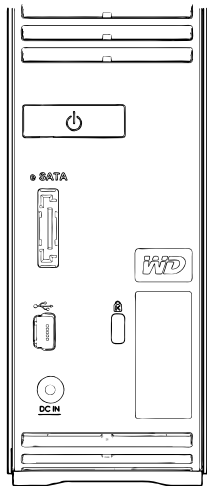
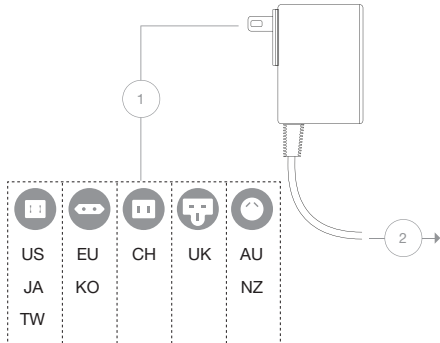

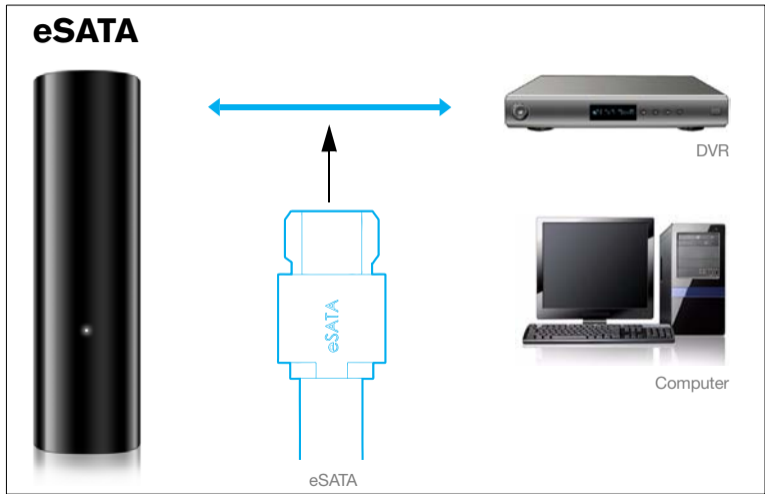
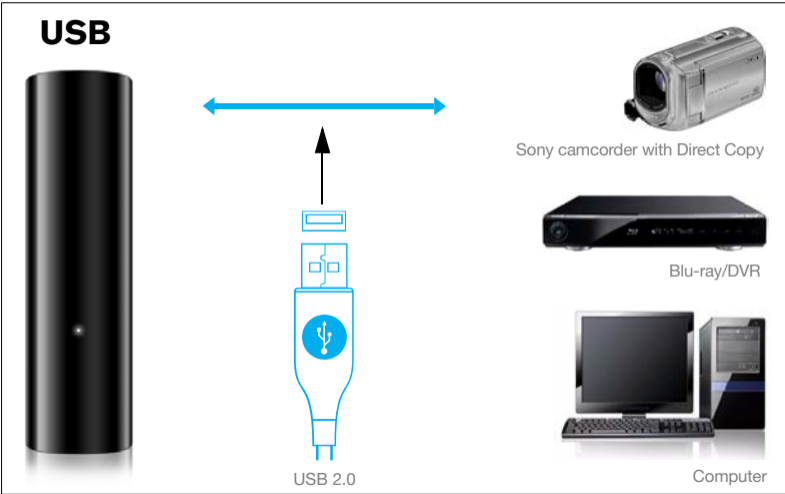
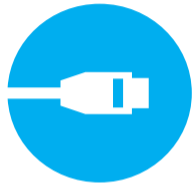

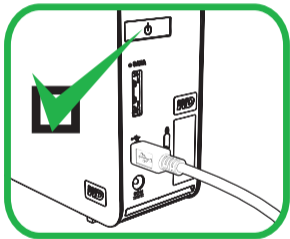

OR

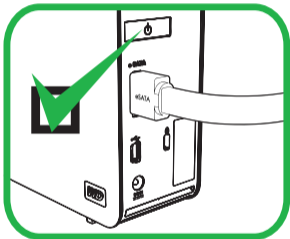

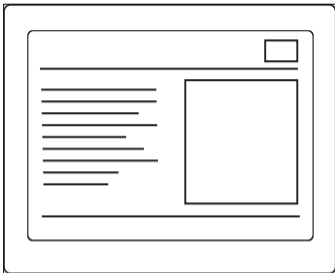

Menu Screen



<http://products.wdc.com/MyBookAV>

# Technical Support Services

<http://support.wdc.com>  
[www.westerndigital.com](http://www.westerndigital.com)



If you encounter problems with this product, please contact WD Technical Support.

---

## North America

English	800.ASK.4WDC (800.275.4932)
Spanish	800.832.4778

---

## Asia Pacific

Japan	0120 994 120 / 00 531 650442
-------	------------------------------

---

## Europe (toll free\*)

	00800.27549338
--	----------------

\* Austria, Belgium, Denmark, France, Germany, Ireland, Italy, Netherlands, Norway, Spain, Sweden, Switzerland, United Kingdom

---

## Europe (non toll free)

---

## Middle East

---

## Africa

	+31.880062100
	+31.880062100
	+31.880062100

Western Digital, WD, the WD logo, and My Book are registered trademarks in the U.S. and other countries; and My Book AV is a trademark of Western Digital Technologies, Inc. Other marks may be mentioned herein that belong to other companies. Specifications subject to change without notice.

© 2011 Western Digital Technologies, Inc.  
All rights reserved.

Western Digital  
3355 Michelson Drive, Suite 100  
Irvine, California 92612  
U.S.A